



# CrewProtect™20

## Multi-Threat Air Decontamination System

### INSTRUCTION FOR INSTALLATION, OPERATION, AND MAINTENANCE

**⚠ DANGER**

Understand manual before use. Operation of this device without understanding the manual and receiving proper training is a misuse of this equipment. Obtain safety information at [tft.com/serial-number](http://tft.com/serial-number).

This instruction manual is intended to familiarize installers, end users, and maintenance personnel with the operation, servicing, and safety procedures associated with this product. This manual should be kept available to all operating and maintenance personnel.



**TASK FORCE TIPS LLC**  
MADE IN USA · [tft.com](http://tft.com)

3701 Innovation Way, Valparaiso, IN 46383-9327 USA  
800-348-2686 · 219-462-6161 · Fax 219-464-7155

## TABLE OF CONTENTS

- 1.0 MEANING OF SAFETY SIGNAL WORDS
- 2.0 GENERAL INFORMATION
  - 2.1 PART IDENTIFICATION
  - 2.2 SPECIFICATIONS
- 3.0 INSTALLATION
  - 3.1 CARTRIDGE INSTALLATION
  - 3.2 MOUNTING
  - 3.3 WIRING
- 4.0 OPERATION
- 5.0 WARRANTY
- 6.0 MAINTENANCE
  - 6.1 CARTRIDGE LIFECYCLE
  - 6.1 CHANGING THE CARTRIDGE
  - 6.2 DISPOSING OF THE CARTRIDGE
- 7.0 REPAIR
- 8.0 OPERATION AND INSPECTION CHECKLIST

**DANGER**

**PERSONAL RESPONSIBILITY CODE**

The member companies of FEMSA that provide emergency response equipment and services want responders to know and understand the following:





1. **Firefighting and Emergency Response are inherently dangerous activities requiring proper training in their hazards and the use of extreme caution at all times.**
2. **IT IS YOUR RESPONSIBILITY** to read and understand any user's instructions, including purpose and limitations, provided with any piece of equipment you may be called on to use.
3. **IT IS YOUR RESPONSIBILITY** to know that you have been properly trained in Firefighting and/or Emergency Response and in the use, precautions, and care of any equipment you may be called upon to use.
4. **IT IS YOUR RESPONSIBILITY** to be in proper physical condition and to maintain the personal skill level required to operate any equipment you may be called upon to use.
5. **IT IS YOUR RESPONSIBILITY** to know that your equipment is in operable condition and has been maintained in accordance with the manufacturer's instructions.
6. **Failure to follow these guidelines may result in death, burns or other severe injury.**

Fire and Emergency Manufacturers and Service Association, Inc.  
PO Box 147, Lynnfield, MA 01940 • [www.FEMSA.org](http://www.FEMSA.org)

© 2020 FEMSA. All Rights Reserved.

## 1.0 MEANING OF SAFETY SIGNAL WORDS

A safety related message is identified by a safety alert symbol and a signal word to indicate the level of risk involved with a particular hazard. Per ANSI Z535.6, the definitions of the four signal words are as follows:

	<b>DANGER</b> indicates a hazardous situation which, if not avoided, will result in death or serious injury.
	<b>WARNING</b> indicates a hazardous situation which, if not avoided, could result in death or serious injury.
	<b>CAUTION</b> indicates a potentially hazardous situation which, if not avoided, could result in minor or moderate injury.
	<b>NOTICE</b> is used to address practices not related to physical injury.

## 2.0 GENERAL INFORMATION

The CrewProtect 20 cabin air decontamination system is connected to the vehicle power system to decontaminate the air in the cabin anytime the truck is actively powered. Periodic replacement of cartridges ensures maximum decontamination of harmful particulates, VOCs, viruses, bacteria, and mold.

### 2.1 PART IDENTIFICATION

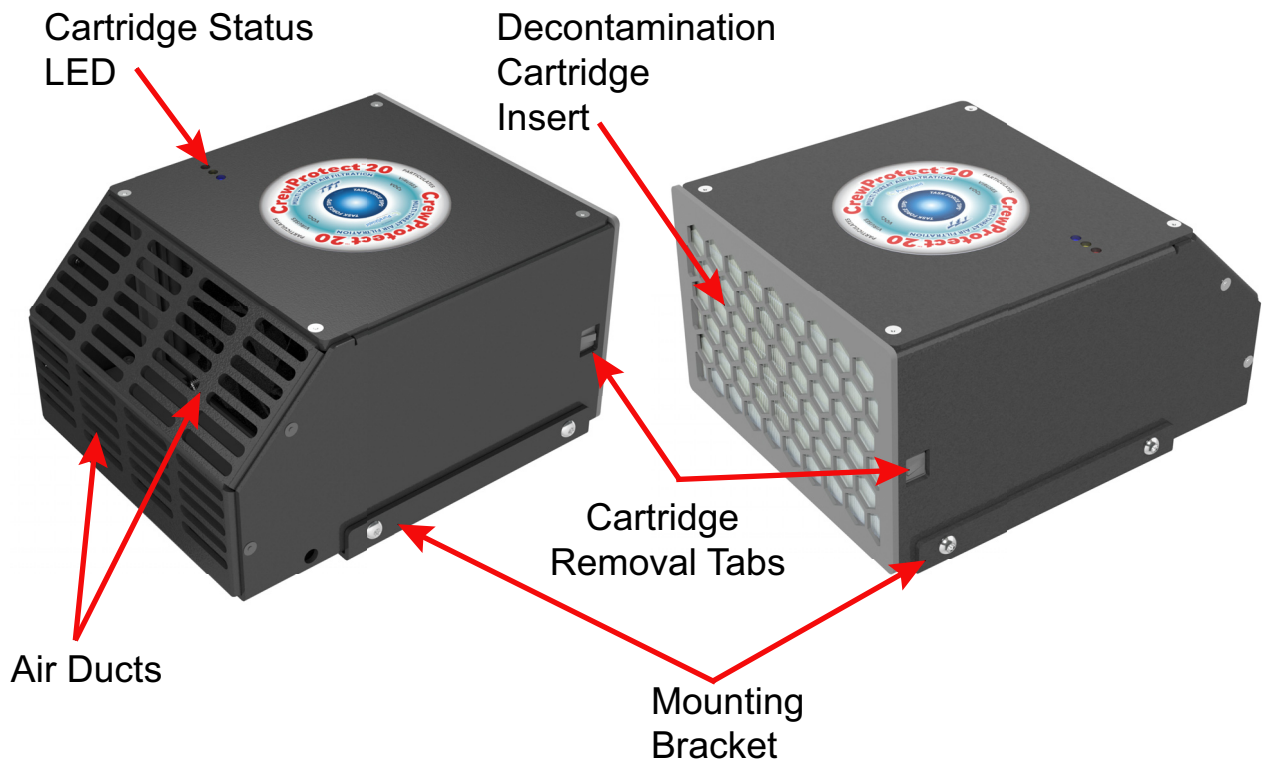

Figure 2.1

### 2.2 SPECIFICATIONS

Dimensions inch (mm)	7 x 6 x 4 (178 x 152 x 102)
Decontamination Protection	Particulates, VOCs, Viruses, Bacteria, Mold
Cartridge Status Indicator	Tri-color LED
Flow Rate	20 CFM (nominal)
Operating Pressure	1 Atmosphere
Current Draw	1A @ 12V or .5A @ 24V
Power Draw	12W (nominal)
Recommended Fuse	2A for 12V or 1A for 24V
Sound (fan running)	45 dB (nominal)

Table 2.2

### 3.0 INSTALLATION

#### 3.1 CARTRIDGE INSTALLATION

The cartridge is shipped in the unit with a protective wrap covering. Prior to starting the unit, remove the protective wrap and reinstall the cartridge following the instructions in "Changing the cartridge" on page 7.

#### NOTICE

Protective plastic wrap should not be removed from the cartridges until ready for installation as the effectiveness of the molecular material starts degrading after exposure to oxygen. Failure to remove the protective wrap from the cartridge prior to installation will cause the unit to overheat and turn off due to lack of air flow.

#### 3.2 MOUNTING

#### WARNING

An inadequately secured unit may become dislodged as a result of a sudden stop or collision, causing injury or equipment damage. To reduce the risk of injury:

- Mount the device on a surface material capable of supporting 50 pounds in the direction of truck travel and 15 pounds in any other direction, per NFPA 1901.
- Use fasteners of a size, strength, and length adequate to securely hold the device.

#### NOTICE

To ensure proper air flow and function of the CrewProtect:

- Choose a location where there is at least 1" of free space around all air ducts.
- Keep air ducts free from obstruction by loose items such as clothing, paper, dirt, or equipment.
- Do not place heavy objects on the unit.
- Do not use the unit as a shelf.

1. Choose a mounting location.
2. To ensure proper hole location, use the mounting bracket as a template.
  - A. Remove (2) screws from the right and left sides of the unit to separate the mounting bracket from the unit.
3. Secure the bracket using (4) nuts and bolts (not provided).
4. Secure the unit to the bracket by replacing the screws removed in step 2A.

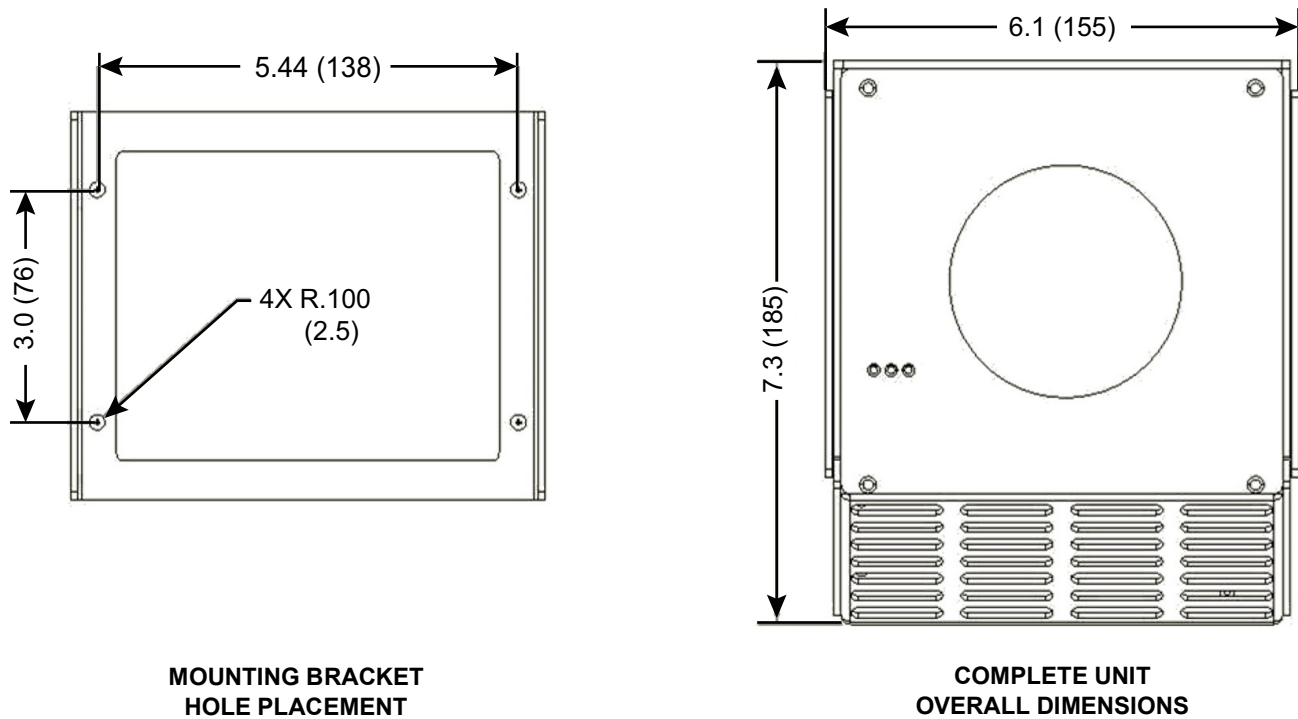

Figure 3.2

### 3.3 WIRING

The CrewProtect 20 is wired to the truck electrical system, allowing continuous decontamination of cabin air while the truck is actively powered. Use the provided wiring diagram to ensure proper wiring.

## NOTICE

**Always disconnect power before installing or servicing electrical components. Failure to do so could cause damage to the circuit boards.**

Requirements:

Minimum Wire Gauge - 18 AWG

Minimum Fuse

12V system - 2A slow blow fuse

24V system - 1A slow blow fuse

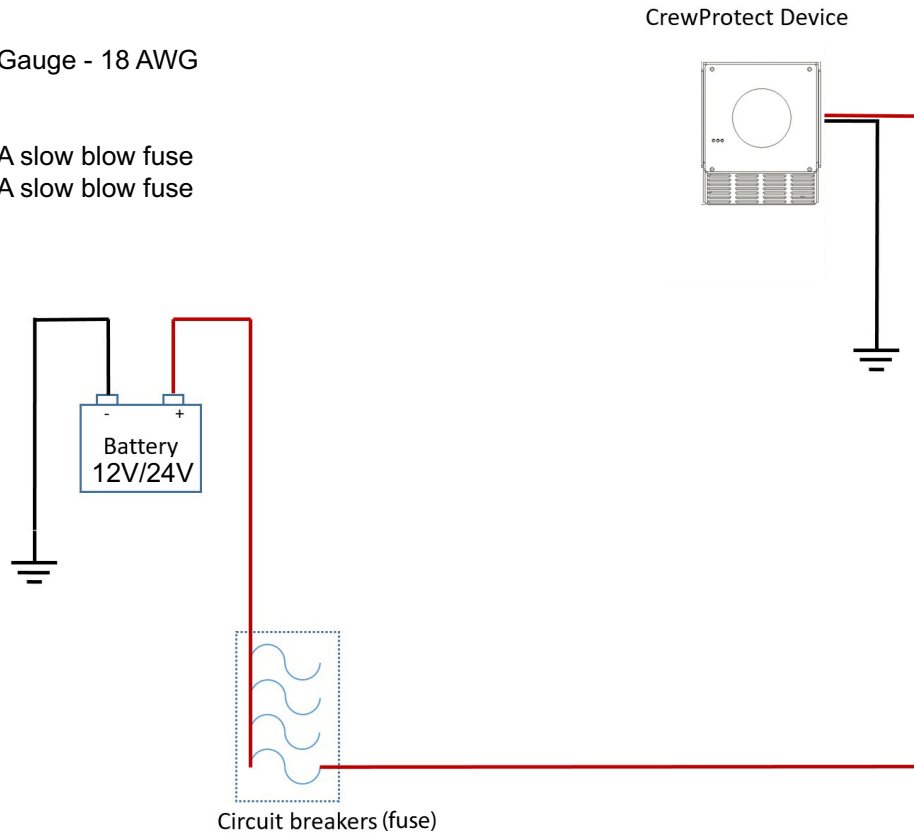

Figure 3.3

### 4.0 OPERATION

Because the CrewProtect 20 is wired directly to the truck electrical system, continuous air decontamination occurs the entire time the truck is actively powered.

Regular cartridge replacement ensures optimal air decontamination. See section 6.0 on page 7 for cartridge lifecycle and replacement instructions.

## 5.0 WARRANTY

Task Force Tips LLC, 3701 Innovation Way, Valparaiso, Indiana 46383-9327 USA (“TFT”) warrants to the original purchaser of its products (“equipment”), and to anyone to whom it is transferred, that the equipment shall be free from defects in material and workmanship during the three (3) year period from the date of purchase. TFT’s obligation under this warranty is specifically limited to replacing or repairing the equipment (or its parts) which are shown by TFT’s examination to be in a defective condition attributable to TFT. To qualify for this limited warranty, the claimant must return the equipment to TFT, at 3701 Innovation Way, Valparaiso, Indiana 46383-9327 USA, within a reasonable time after discovery of the defect. TFT will examine the equipment. If TFT determines that there is a defect attributable to it, TFT will correct the problem within a reasonable time. If the equipment is covered by this limited warranty, TFT will assume the expenses of repair.

If any defect attributable to TFT under this limited warranty cannot be reasonably cured by repair or replacement, TFT may elect to refund the purchase price of the equipment, less reasonable depreciation, in complete discharge of its obligations under this limited warranty. If TFT makes this election, claimant shall return the equipment to TFT free and clear of any liens and encumbrances.

This is a limited warranty. The original purchaser of the equipment, any person to whom it is transferred, and any person who is an intended or unintended beneficiary of the equipment, shall not be entitled to recover from TFT any consequential or incidental damages for injury to person and/or property resulting from any defective equipment manufactured or assembled by TFT.

It is agreed and understood that the price stated for the equipment is in part consideration for limiting TFT’s liability. Some states do not allow the exclusion or limitation of incidental or consequential damages, so the above may not apply to you.

TFT shall have no obligation under this limited warranty if the equipment is, or has been, misused or neglected (including failure to provide reasonable maintenance) or if there have been accidents to the equipment or if it has been repaired or altered by someone else.

**THIS IS A LIMITED EXPRESS WARRANTY ONLY. TFT EXPRESSLY DISCLAIMS WITH RESPECT TO THE EQUIPMENT ALL IMPLIED WARRANTIES OF MERCHANTABILITY AND ALL IMPLIED WARRANTIES OF FITNESS FOR A PARTICULAR PURPOSE. THERE IS NO WARRANTY OF ANY NATURE MADE BY TFT BEYOND THAT STATED IN THIS DOCUMENT.**

This limited warranty gives you specific legal rights, and you may also have other rights which vary from state to state.

## 6.0 MAINTENANCE

### 6.1 CARTRIDGE LIFECYCLE

The cartridge will function for 1,800 hours of continuous usage or 6 months of intermittent use. The current condition of the cartridge is tracked via the three LED lights on the prominent face of the device with the following statuses:

Hours of Continuous Use		Months of Intermittent Use	LED Color
0-1500	or	0-4.9	Solid Blue
1501-1799		5-5.9	Solid Yellow
1800+		6+	Solid Red

Table 6.0

## NOTICE

To ensure the device is optimally decontaminating the cabin air, the cartridge should be changed when the LED color is YELLOW.

When the indicator turns RED, the device will stop operating until the cartridge is replaced with a new cartridge.

### 6.1 CHANGING THE CARTRIDGE

To Change the Cartridge:

1. Press the cartridge tabs in on both sides.
2. Pull the old cartridge off of the unit.
3. Place the new cartridge into the unit.  
The cartridge only fits in 1 orientation.  
Push the new cartridge in until the tabs click into place.

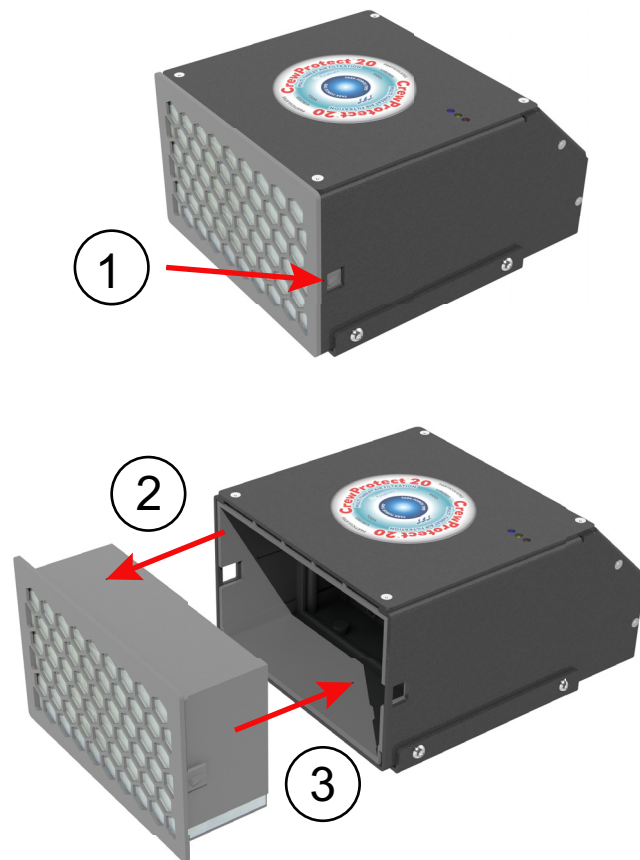

Figure 6.1

## NOTICE

All replacement parts must be obtained from Task Force Tips and its approved dealer network to assure proper performance and operation of the device.

### 6.2 DISPOSING OF THE CARTRIDGE

The cartridge material is designed to neutralize the toxins captured in the cartridge, rendering them no longer hazardous. Used cartridges can be disposed of in normal refuse.

## 7.0 REPAIR

Factory service is available. Factory serviced equipment is repaired by experienced technicians, tested to original specifications, and promptly returned. Call TFT service department at 1-800-348-2686 to troubleshoot and if needed, directions for return.



**Any alterations to the product or its markings could diminish safety and constitutes a misuse of this product.**

## 8.0 OPERATION AND INSPECTION CHECKLIST

**BEFORE EACH USE and BEFORE BEING PLACED BACK IN SERVICE**, the CrewProtect 20 must be inspected to this checklist:

1. There is no obvious damage such as missing, broken or loose parts, damaged labels, etc.
2. The unit is securely fastened to the truck.
3. LED status lights indicating cartridge status are in the acceptable range (Blue or Yellow).
4. All air ducts are clean and unobstructed.
5. The area around the device is clean and free of loose debris.
6. There are no objects sitting on top of the device.
7. All markings are legible.



**Equipment failing any part of the checklist is unsafe for use and must have the problem corrected before use or being placed back into service. Operating equipment that has failed the checklist is a misuse of this equipment.**